

PQ1CG1

TO-220 Type Chopper Regulator

Features

- Maximum switching current: 1.5A
- Built-in oscillation circuit
(Oscillation frequency: TYP.100kHz)
- Built-in overheat protection, overcurrent protection function
- Variable output voltage(1.26 to 35V/-1.26 to -30V)
[Possible to select step-down output / porality inversion output according to external connection circuit]

Applications

- Personal computers
- Printers

Outline Dimensions

(Unit : mm)

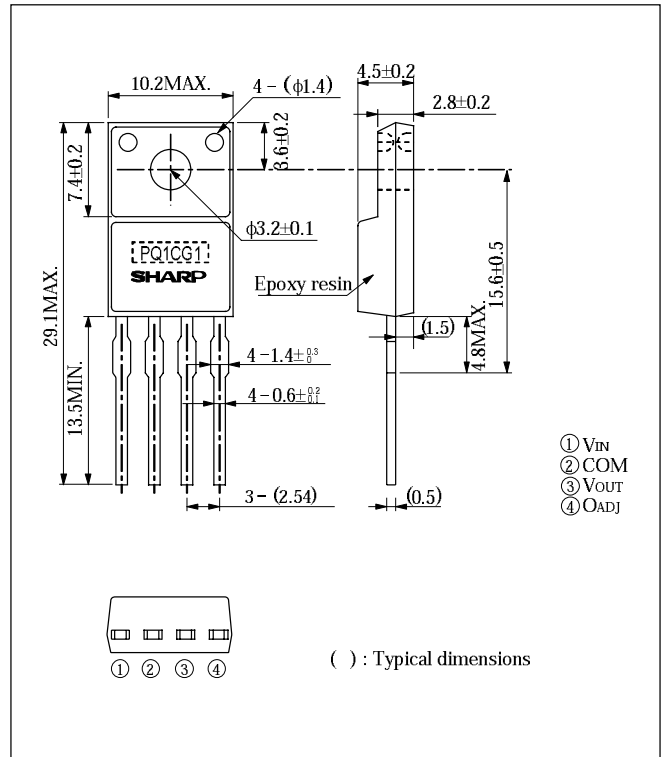

Absolute Maximum Ratings

(T_a=25°C)

Parameter	Symbol	Rating	Unit
*1 Input voltage	V _{IN}	40	V
Output adjustment terminal voltage	V _{ADJ}	7	V
Dropout voltage	V _{LO}	41	V
*2 Output-COM voltage	V _{OUT}	-1	V
Switching current	I _{SW}	1.5	A
*3 Power dissipation	P _{D1}	1.4	W
	P _{D2}	14	W
*4 Junction temperature	T _j	150	°C
Operating temperature	T _{opr}	-20 to +80	°C
Storage temperature	T _{stg}	-40 to +150	°C
Soldering temperature	T _{sol}	260(For 10s)	°C

*1 Voltage between V_{IN} and COM

*2 Voltage between V_{OUT} and COM

*3 P_{D1}: No heat sink, P_{D2}: With infinite heat sink

*4 Overheat protection may operate at 125 ≤ T_j ≤ 150°C.

• Please refer to the chapter " Handling Precautions ".

SHARP

Notice In the absence of confirmation by device specification sheets, SHARP takes no responsibility for any defects that may occur in equipment using any SHARP devices shown in catalogs, data books etc. Contact SHARP in order to obtain the latest device specification sheets before using any SHARP device.
Internet Internet address for Electronic Components Group <http://www.sharp.co.jp/ecg/>

Electrical Characteristics

(Unless otherwise specified, $V_{IN}=12V$, $I_o=0.2A$, $V_o=5V$, $T_a=25^\circ C$)

Parameter	Symbol	Conditions	MIN.	TYP.	MAX.	Unit
Output saturation voltage	V_{SAT}	$I_o=1A$, No L, D, C_o	—	1	1.5	V
Reference voltage	V_{ref}	—	1.235	1.26	1.285	V
Reference voltage temperature fluctuation	ΔV_{ref}	$T_j=0$ to $125^\circ C$	—	± 0.5	—	%
Load regulation	$ R_{egL} $	$I_o=0.2$ to $1A$	—	0.1	1.5	%
Line regulation	$ R_{egI} $	$V_{IN}=8$ to $35V$	—	0.5	2.5	%
Efficiency	η	$I_o=1A$	—	82	—	%
Oscillation frequency	f_o	—	80	100	120	kHz
Oscillation frequency temperature fluctuation	Δf_o	$T_j=0$ to $125^\circ C$	—	± 2	—	%
Maximum duty	D_{MAX}	④ terminal=open	90	—	—	%
Overcurrent detection level	I_L	No L, D, C_o	1.55	2	2.6	A
OFF-state consumption current	I_{qs}	$V_{IN}=40V$, No.4 pin=3V	—	8	12	mA

Fig. 1 Test Circuit

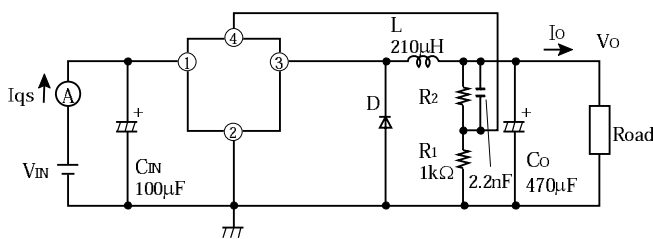

L : HK-14D100-2110 (made by Toho Co.)
 D : ERC80-004 (made by Fuji electronics Co.)

Fig. 2 Power Dissipation vs. Ambient Temperature

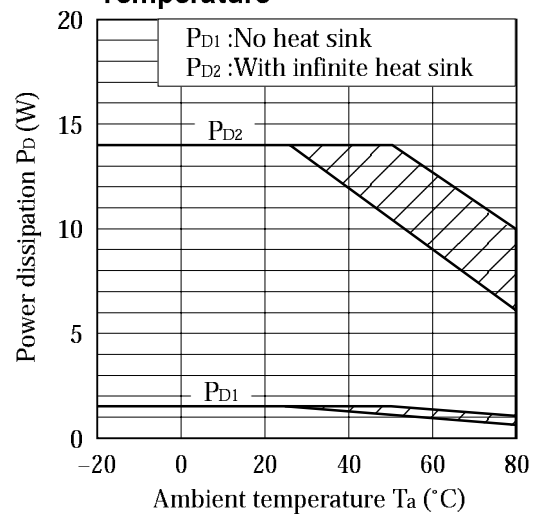

Note) Oblique line portion : Overheat protection may operate in this area.

Fig. 3 Overcurrent Protection Characteristics (Typical Value)

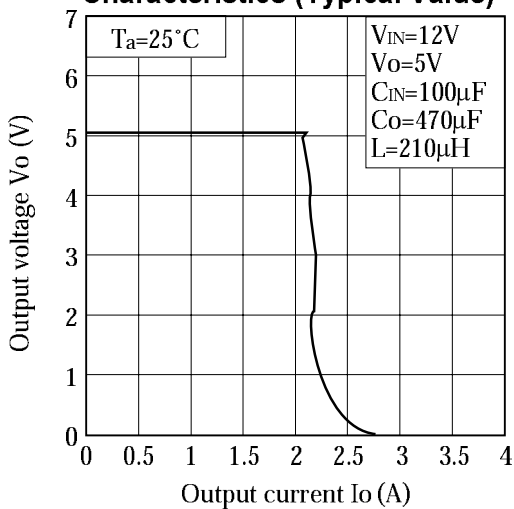

Fig. 4 Efficiency vs. Input Voltage

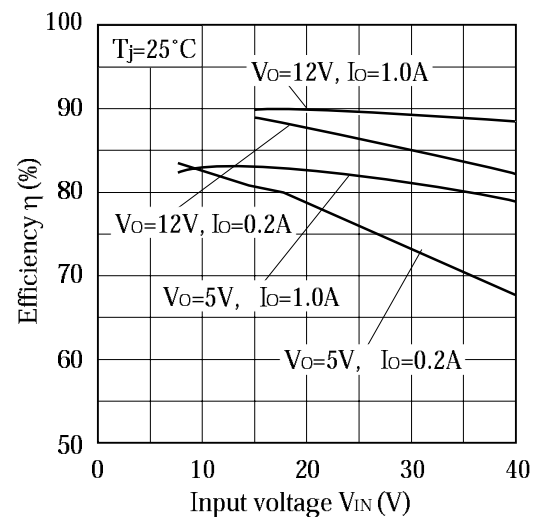

Fig. 5 Switching Current vs. Output Saturation Voltage

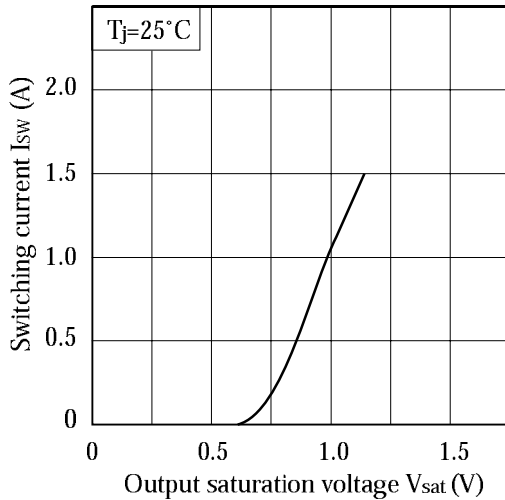

Fig. 6 Reference Voltage Fluctuation vs. Junction Temperature

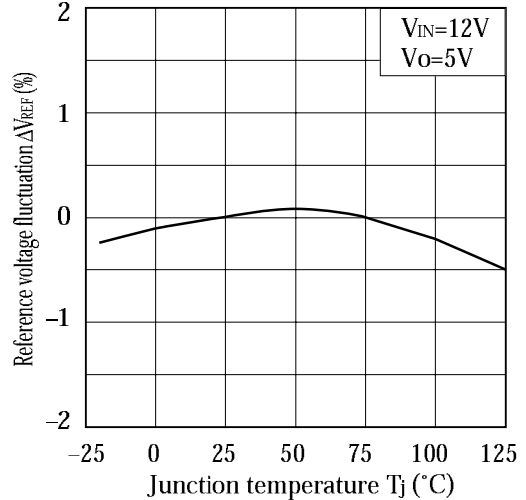

Fig. 7 Load Regulation vs. Output Current

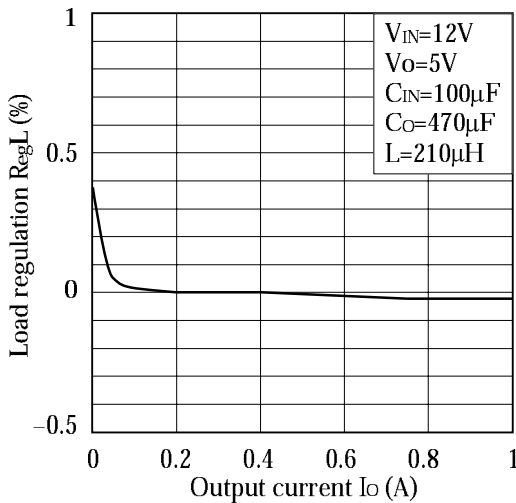

Fig. 8 Line Regulation vs. Input Voltage

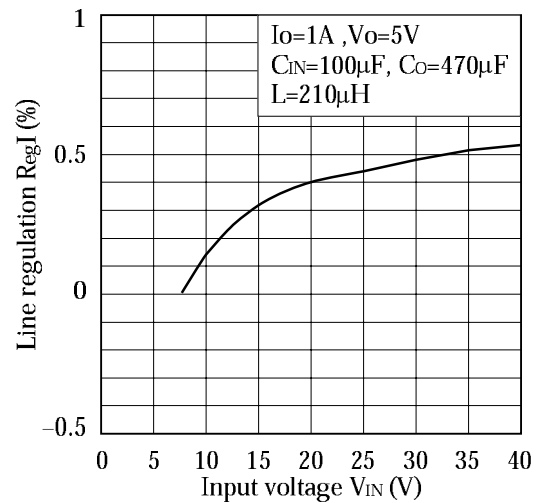

Fig. 9 Oscillation Frequency Fluctuation vs. Junction Temperature

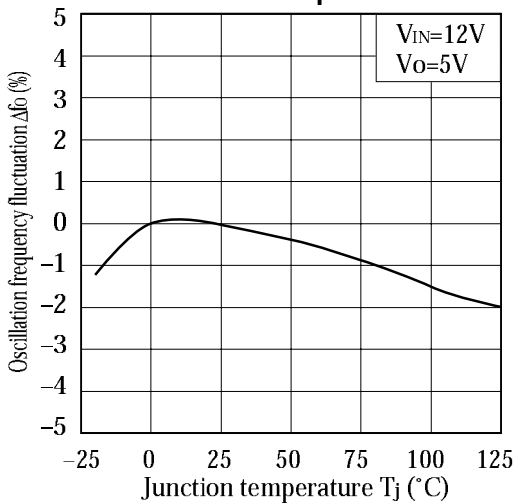

Fig.10 Overcurrent Detecting Level vs. Junction Temperature

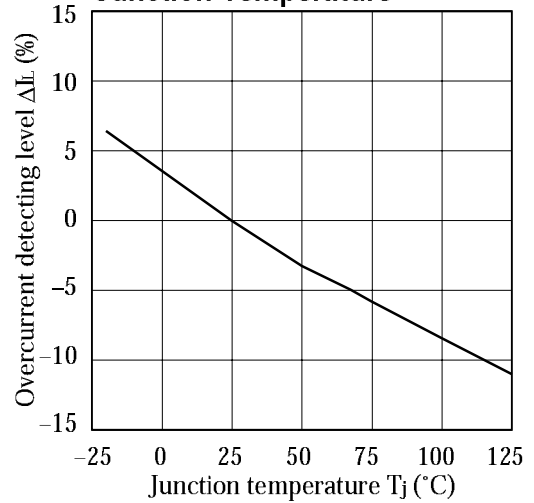
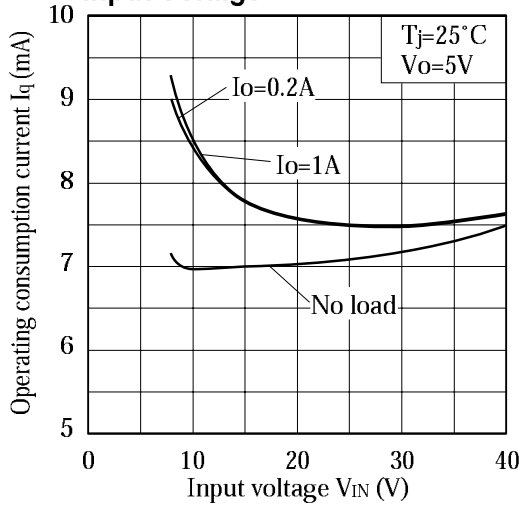
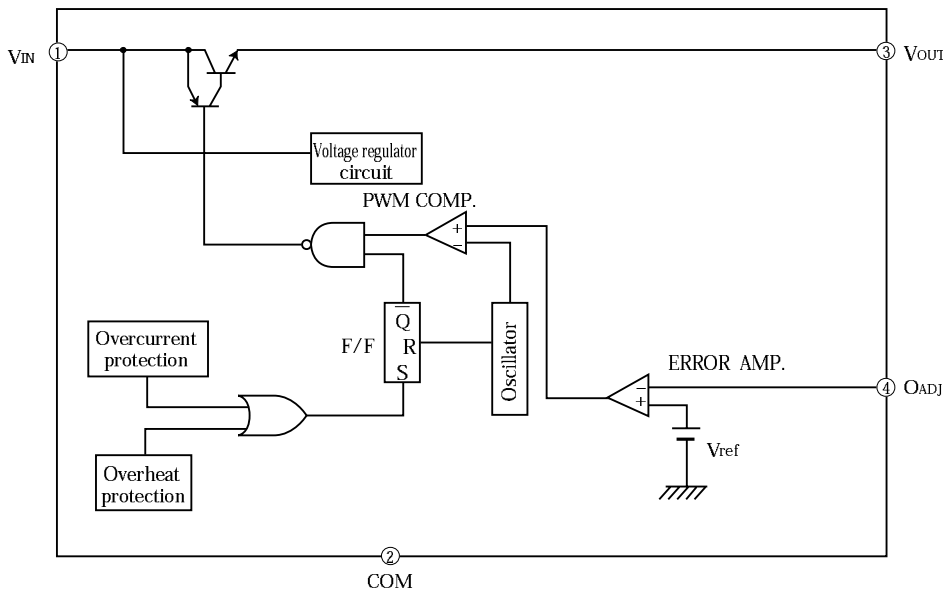

Fig.11 Operating Consumption Current vs. Input Voltage



■ Block Diagram



■ Step-down Output Type Circuit Diagram(5V Output)

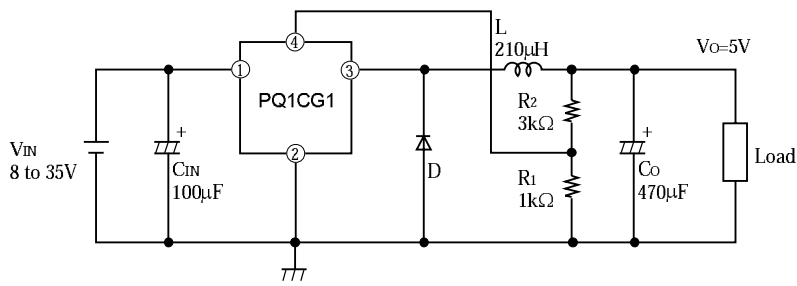

■ Inversion Output Type Circuit Diagram(-5V Output)

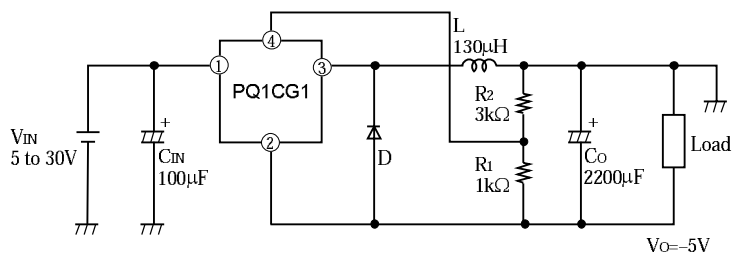

NOTICE

- The circuit application examples in this publication are provided to explain representative applications of SHARP devices and are not intended to guarantee any circuit design or license any intellectual property rights. SHARP takes no responsibility for any problems related to any intellectual property right of a third party resulting from the use of SHARP's devices.
- Contact SHARP in order to obtain the latest device specification sheets before using any SHARP device. SHARP reserves the right to make changes in the specifications, characteristics, data, materials, structure, and other contents described herein at any time without notice in order to improve design or reliability. Manufacturing locations are also subject to change without notice.
- Observe the following points when using any devices in this publication. SHARP takes no responsibility for damage caused by improper use of the devices which does not meet the conditions and absolute maximum ratings to be used specified in the relevant specification sheet nor meet the following conditions:
 - (i) The devices in this publication are designed for use in general electronic equipment designs such as:
 - Personal computers
 - Office automation equipment
 - Telecommunication equipment [terminal]
 - Test and measurement equipment
 - Industrial control
 - Audio visual equipment
 - Consumer electronics
 - (ii) Measures such as fail-safe function and redundant design should be taken to ensure reliability and safety when SHARP devices are used for or in connection with equipment that requires higher reliability such as:
 - Transportation control and safety equipment (i.e., aircraft, trains, automobiles, etc.)
 - Traffic signals
 - Gas leakage sensor breakers
 - Alarm equipment
 - Various safety devices, etc.
 - (iii) SHARP devices shall not be used for or in connection with equipment that requires an extremely high level of reliability and safety such as:
 - Space applications
 - Telecommunication equipment [trunk lines]
 - Nuclear power control equipment
 - Medical and other life support equipment (e.g., scuba).
- Contact a SHARP representative in advance when intending to use SHARP devices for any "specific" applications other than those recommended by SHARP or when it is unclear which category mentioned above controls the intended use.
- If the SHARP devices listed in this publication fall within the scope of strategic products described in the Foreign Exchange and Foreign Trade Control Law of Japan, it is necessary to obtain approval to export such SHARP devices.
- This publication is the proprietary product of SHARP and is copyrighted, with all rights reserved. Under the copyright laws, no part of this publication may be reproduced or transmitted in any form or by any means, electronic or mechanical, for any purpose, in whole or in part, without the express written permission of SHARP. Express written permission is also required before any use of this publication may be made by a third party.
- Contact and consult with a SHARP representative if there are any questions about the contents of this publication.